**Caratteristiche:**

Diffusori a flusso elicoidale.

Costruzione:

Acciaio verniciato bianco
RAL 9010.

Impiego:

A soffitto, in mandata e ripresa.
Altezza di installazione:
BQSN = 2,7 - 3,6 m.

Fissaggio:

Fissaggio con viti laterali o a
mezzo vite centrale su ponte di
montaggio.

Accessori:

- Plenum in acciaio zincato
standard o isolato, con o senza
rete equalizzatrice, serranda di
taratura e ponte di montaggio.

Characteristics:

Swirl diffusers.

Construction:

RAL 9010 white painted steel.

Utilization:

For ceiling installation and for air
intake and delivery.

Installation height:

BQSN = 2,7 - 3,6 m.





Fixing:

Fixing by using lateral screws or
central screw on mounting bridge.





Accessories:

- Galvanized steel plenum,
standard or insulated, with
or without equalizer sheet,
calibration damper and
mounting bridge.

PREZZI / PRICES

					
		BQSN		BQSN-R con anello/with ring	
mm	€	€	PEZZI PIECES	€	PEZZI PIECES
* 600	-	-	5	-	3
625	-	-	5	-	3

PREZZI / PRICES PLENUM

		Cannotto Spigot							
			PQZ-1	PQZI-1	PQZ-2	PQZI-2	Serranda Damper	Equalizzatore Equalizer	Ponte di fissaggio Fixing bridge
mm	Ø mm	€	€	€	€	€	€	€	€
600	248	-	-	-	-	-	-	-	-
625	298	-	-	-	-	-	-	-	-

DISEGNI / DRAWINGS

DIAGRAMMA SCELTA RAPIDA / QUICK SELECTION DIAGRAM

TABELLA DI SELEZIONE / SELECTION TABLE

Modello Model	A_v [m^2]	Q [m^3/h]		L_{wa} [dB(A)]		$X_{10,20}$ [m]		Dp_t [Pa]	
		min	max	min	max	min	max	min	max
BQSN 600	0,0365	350	810	23	43	3,2	7,3	10	50
BQSN 625	0,0365	350	810	23	43	3,2	7,3	10	50

DISEGNI / DRAWINGS

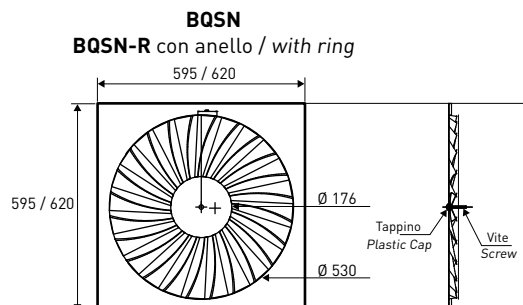
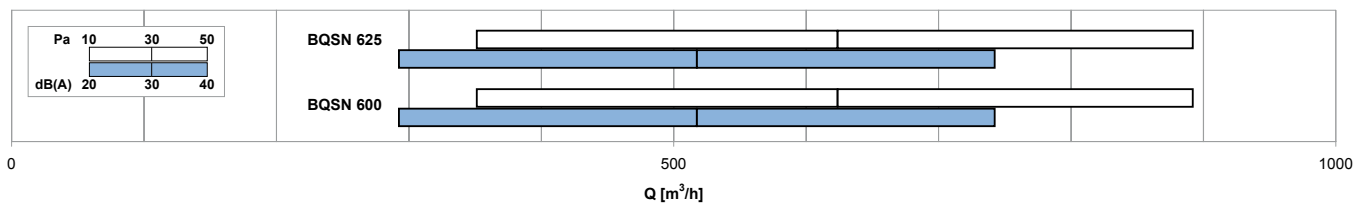
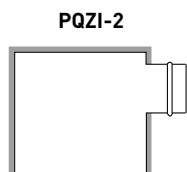
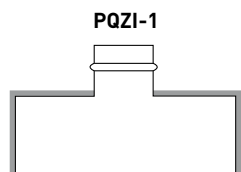
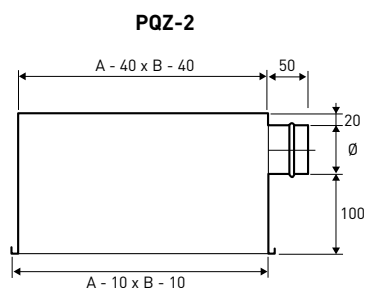
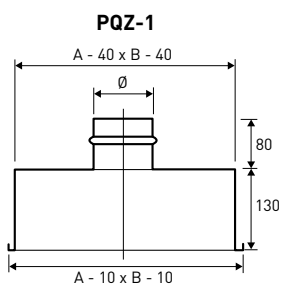
Plenum isolato esternamente spessore 6 mm
Plenum externally insulated thickness 6 mm

